

ATLANTIC RANGE

A selection of lightweight, decorative & specialist handles.

DECORATIVE CARTON HANDLES

Rope Handle



- 4 sizes of rope handles: 9", 12", 15", 18"
- Carries up to 11kg

Washer disk (Reinforcer)

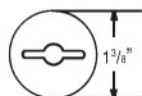

- White only
- Provides reinforcement to any corrugated or cardboard box

Bracelet



- Carries up to 9kg

Double Braid



- Carries up to 9kg

LIGHTWEIGHT CARTON HANDLES

6" Standard



- Carries up to 7kg

Mini-Escort



- Carries up to 7kg

Mid-Escort



- Carries up to 9kg

SPECIALIST HANDLES

Twistlock Swivel

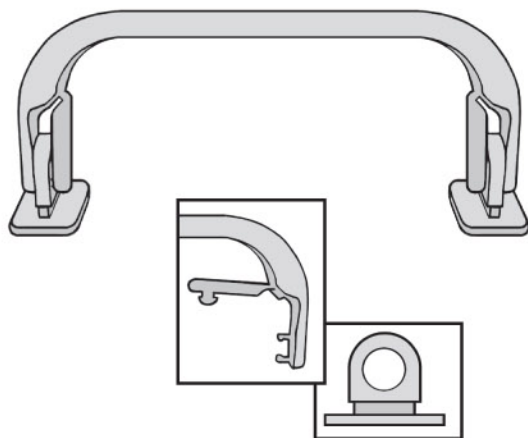

- Easy snap lock - New design
- Carries up to 20kg
- No tools required to fit

Carry-Aid

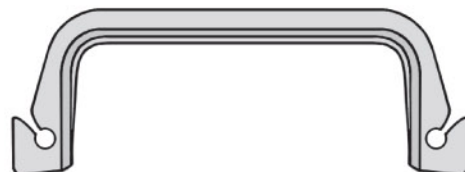

- Carries up to 15kg
- Suitable for: Packages tied with string

Carry-All

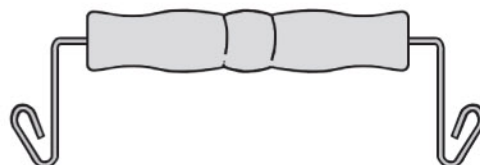

- Carries up to 36kg
- Suitable for: Packages tied with string

For more information please contact

ITEM PRODUCTS (NPD) LIMITED

101 PARK STREET, LUTON, BEDS LU1 3HG

Tel: 01582 391 898 Fax: 01582 391 998 email: info@item-products.co.uk Web Site: www.item-products.co.uk

ATLANTIC RANGE

HEAVY DUTY CARTON HANDLES

6 1/2" Heavy Duty

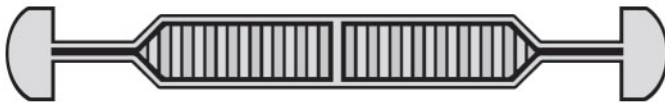

Carries up to 20kg

7" Heavy Duty

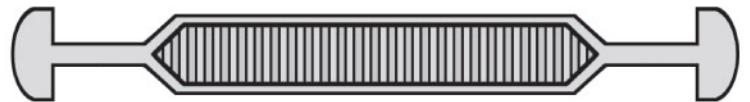

Carries up to 20kg

8" Heavy Duty

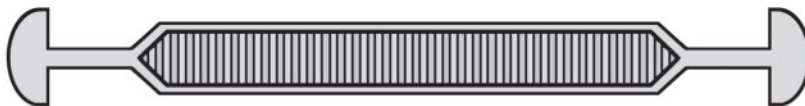

Carries up to 30kg

9" Heavy Duty

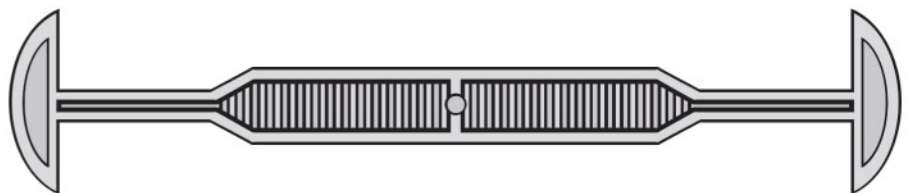

In 2 sizes: 9", 12"
Carries up to 45kg

Standard Escort

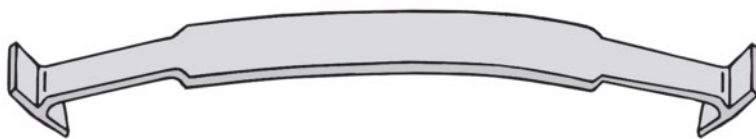

Carries up to 18kg

Heavy Duty Escort

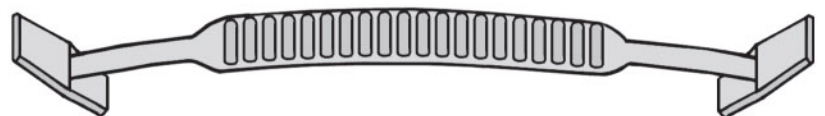

Carries up to 35kg

For more information please contact

ITEM PRODUCTS (NPD) LIMITED

101 PARK STREET, LUTON, BEDS LU1 3HG

Tel: 01582 391 898 Fax: 01582 391 998 email: info@item-products.co.uk Web Site: www.item-products.co.uk