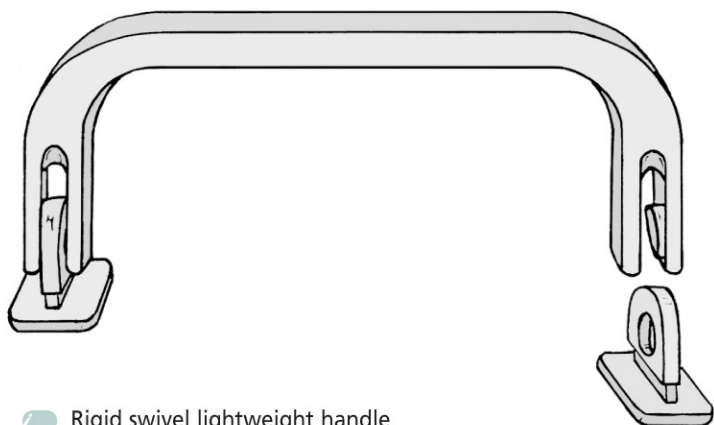
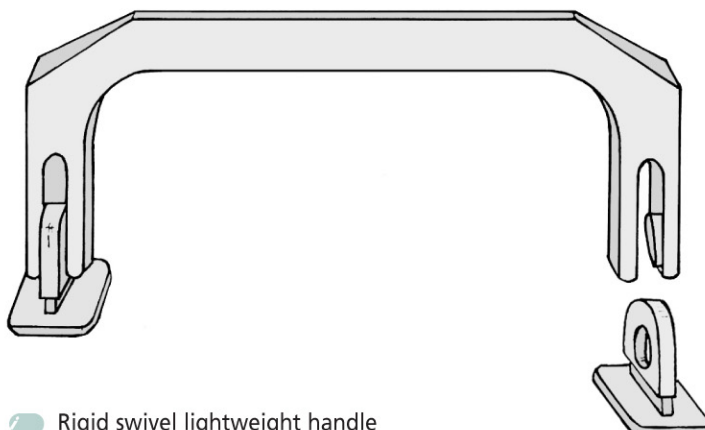

RIGID SWIVEL HANDLES

Ref: 80

- Rigid swivel lightweight handle
- For use with polypropylene, corrugated plastic & board cases
- Colours available: • Black • White • Red • Blue

Ref: 89

- Rigid swivel lightweight handle
- For use with polypropylene, corrugated plastic & board cases
- Colours available: • Black • White • Red • Blue

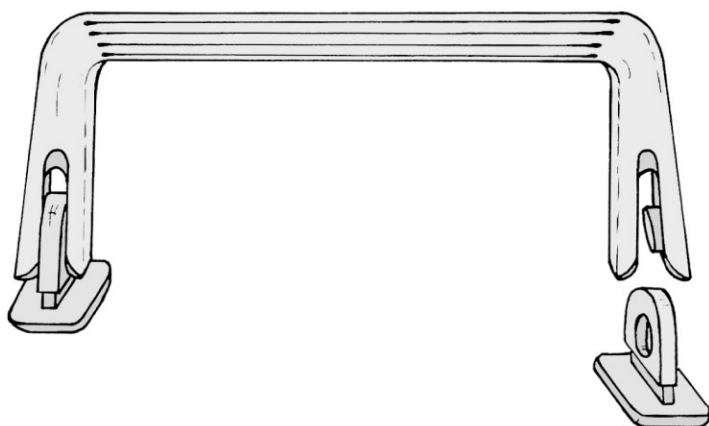
Ref: 82

- Rigid swivel lightweight handle
- For use with polypropylene, corrugated plastic & board cases
- Colours available: • Black • White • Red • Blue

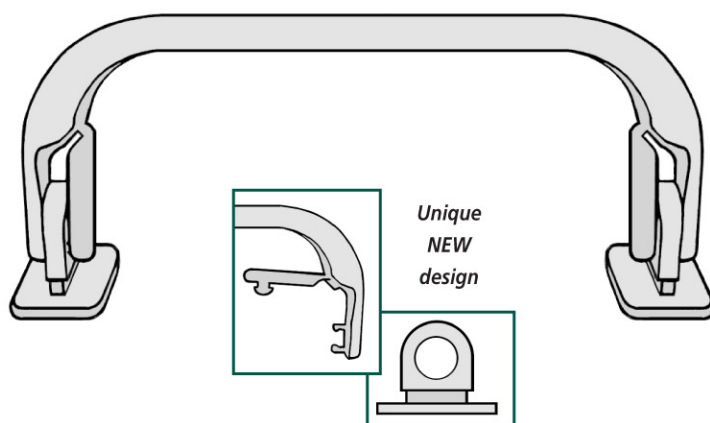
Atlantic Twistlock Swivel

- Easy snap lock - New design
- Carries up to 20kg
- No tools required to fit

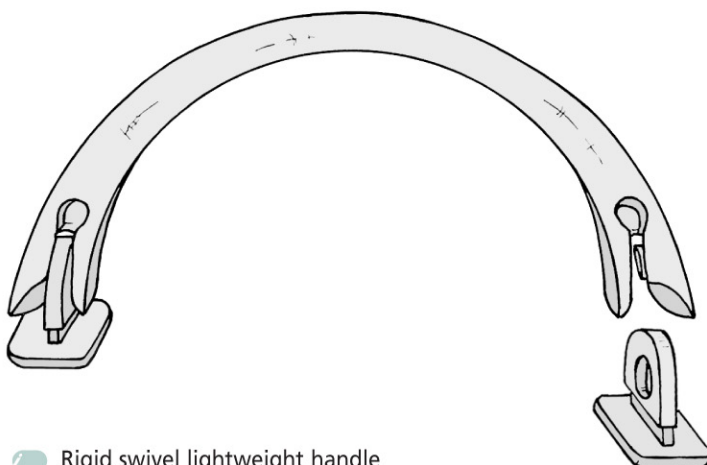
Ref: 85

- Rigid swivel lightweight handle
- For use with polypropylene, corrugated plastic & board cases
- Colours available: • Black • White • Red • Blue

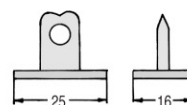
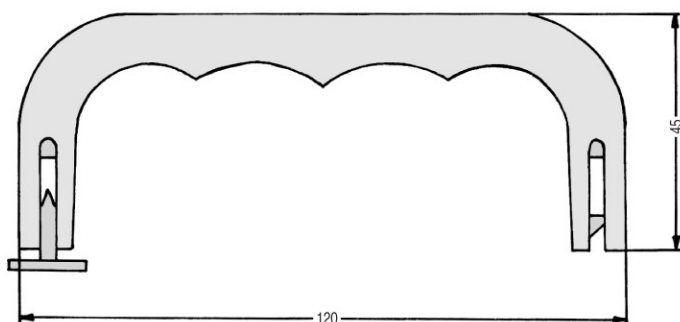
EKS 921.0

- Swivel carrying handle
- Top loading
- Carries up to 5kg

For more information please contact

ITEM PRODUCTS (NPD) LIMITED

101 PARK STREET, LUTON, BEDS LU1 3HG

Tel: 01582 391 898 Fax: 01582 391 998 email: info@item-products.co.uk Web Site: www.item-products.co.uk